

# Deterministic Equations for Computer Approximation of ITU-R P.1546-2

---

**Sid Shumate**

**International Symposium on Advanced Radio Technologies, ClimDiff 2008  
and The Working Party Meetings for ITU-R WP 3J, 3K, 3L and 3M  
hosted by National Institute of Standards and Technology,  
At Hotel Boulderado, Boulder, Colorado  
June 2 - 4, 2008**

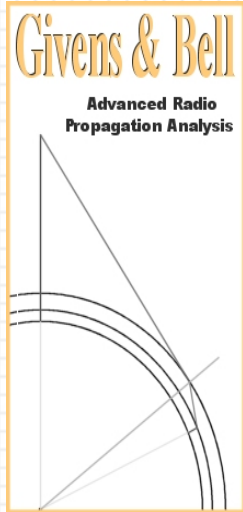

# The original purpose:

- **A new, comprehensive FM Radio/ IBOC (HD Radio) vehicular reception analysis report, considering:**
  - **Signal Strength**
  - **Noise Interference**
  - **Analog FM Interference**
  - **HD Radio Interference**
  - **From all sources, including surrounding FM radio stations.**

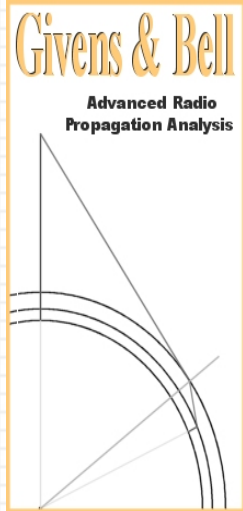

## Which Required:

- **A Longley-Rice Implementation with high positional (terrain point-by-terrain point) prediction accuracy.**
- **NOTE: Longley-Rice software is a two-part system consisting of the NTIA Irregular Terrain Model (ITM) subroutines, and a wrap-around input-output software package.**

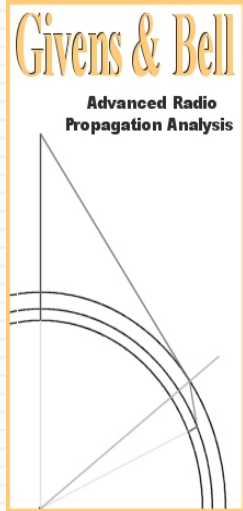

## What I found:

- **The open source Longley-Rice wrap-around software SPLAT! calculates pixel by pixel and could be highly location accurate, but:**
- **The Longley Rice ITM model subroutine core does not support high location accuracy prediction.**

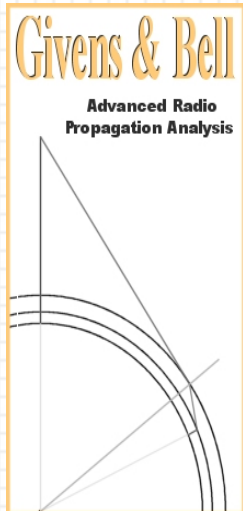

## What is needed?

- **To create a high position accuracy version of the ITM, the Irregular Terrain With Obstructions Model (ITWOM) unveiled at the NAB 2008 Broadcast Engineering Conference, it was necessary to replace and supplement the obsolete terrain diffraction calculations in the line-of-sight range and near obstructions, with Radiative Transfer Engine (RTE) functions.**

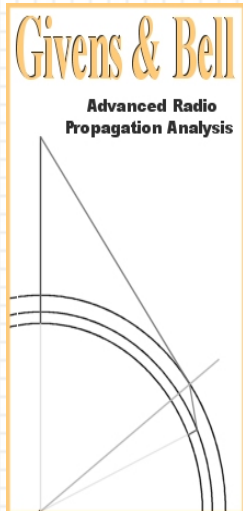

# Developing Practical RTE Approximations

- **The development of practical RTE approximations for high speed computation was based on the data from Figures 1, 9 and 17 in ITU-R P.1546-2.**
- **This promotes compatibility between the ITU recommendations and this new Longley Rice implementation.**
- **The combination and use of these practical approximation equations in a computer worksheet to duplicate the results of ITU-R P.1546-2 provides a proof of concept.**

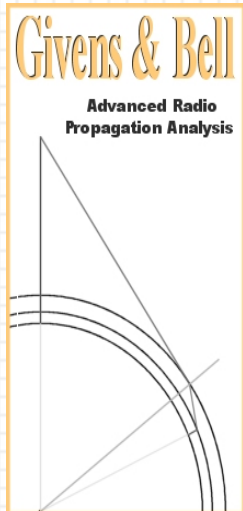

# The Approximations Worksheet

- **Requires only the input of:**
  - Frequency, in MHz
  - Transmitter height in meters, AGL
  - Receiver height in meters, AGL
  - Path Length in kilometers
  - Optionally, a preset clutter canopy height of 25.3 meters can also be changed.
- **Provides results similar to ITU-P-1546 figures 1, 9, and 17.**

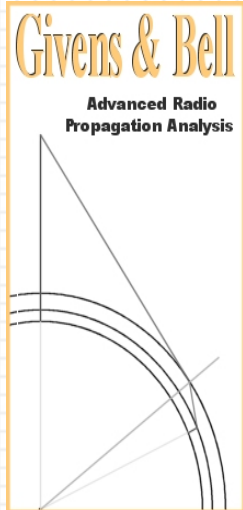

# Supplemental Handout CD

- **CD contains:**
- **Paper**
- **Presentation**
- **The ITU-P.1546 worksheet using Shumate's Approximations, which requires only these inputs to get results:**
  - **Transmit and receive heights AGL**
  - **Path length**
  - **Frequency**



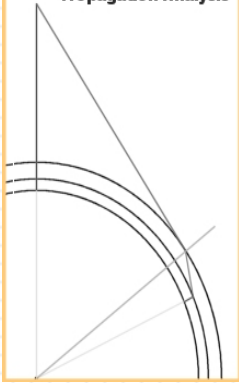

# Comparison of Results:

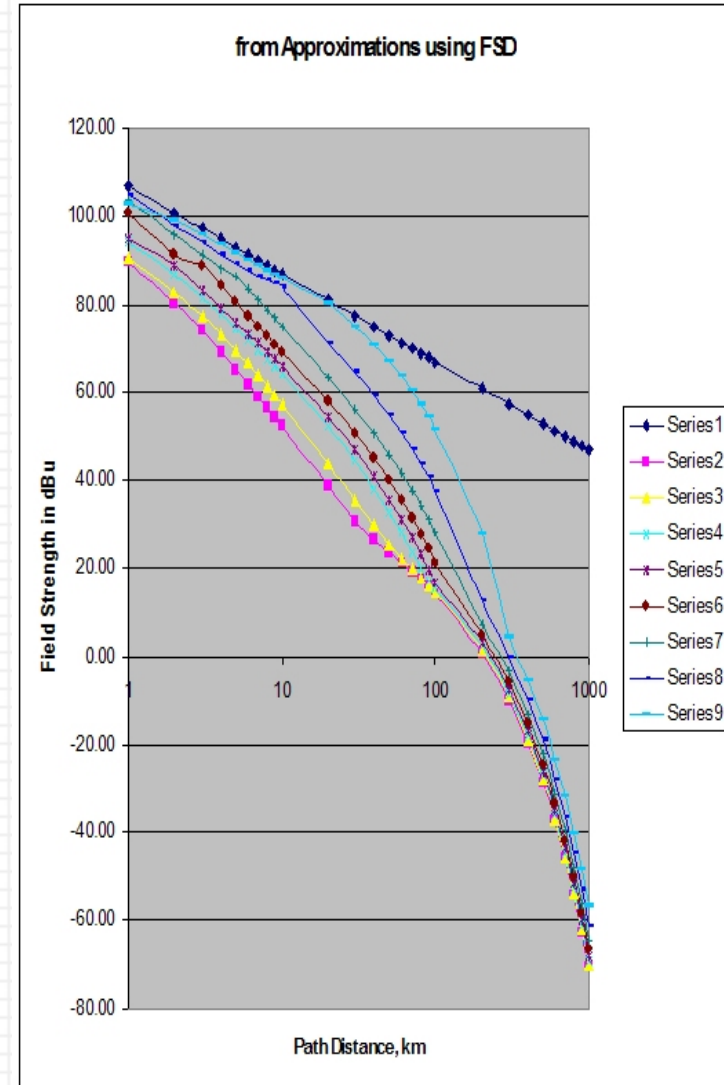
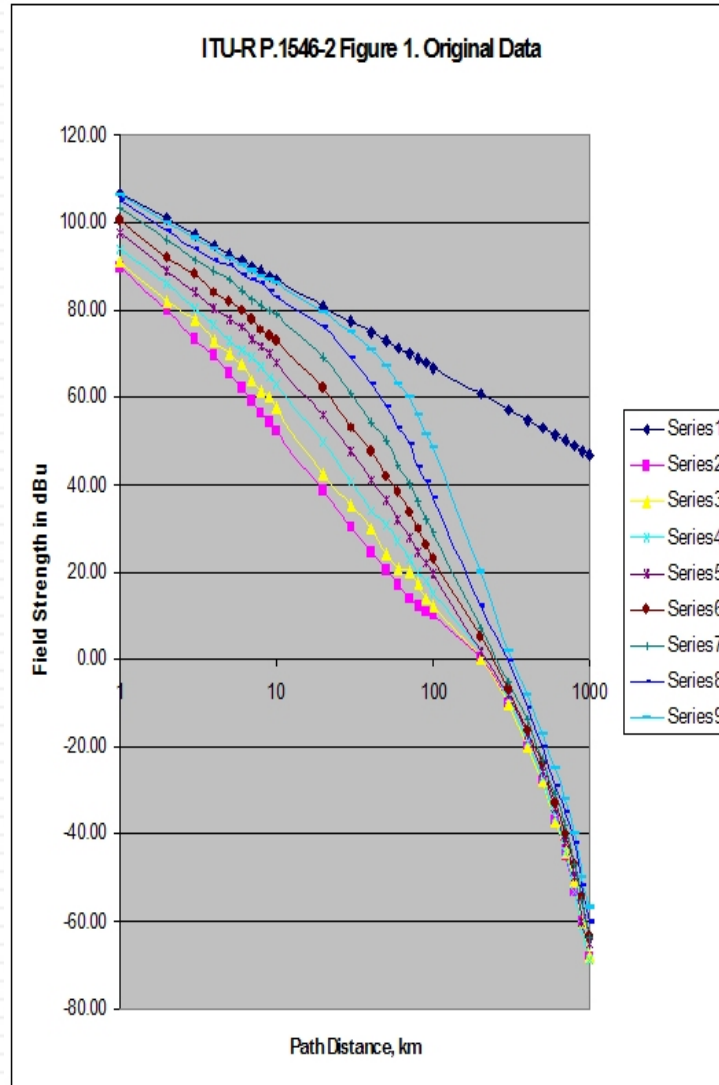

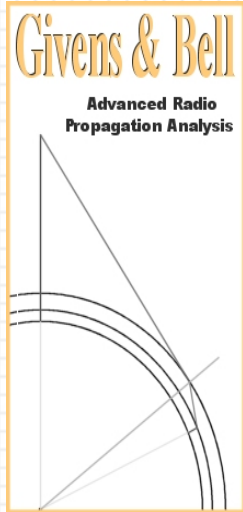

# Primary Assumptions re: Data Accuracy of ITU-P.1546

- The data embodied in Figures 1, 9 and 17 are assumed to be correct.
- Results of approximation equations that do not match these results are to be rejected.

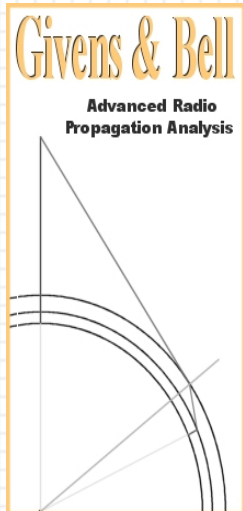

## Discovered along the way:

- The average simple absorption value of the clutter in P.1546, valid until the RTE Id mode takes over, is 0.0195 dB/meter.
- The ITU-R P.1546 data embodies a consistent clutter layer with a clutter canopy at 25.3 meters above AGL. Above this level, Snells' Law must be used to determine the cluttered path length.
- The average refractive index of the clutter in P.1546 is 1.0010
- For a scenario where the transmitter is above a clutter canopy, there is another RTE mode after Id.

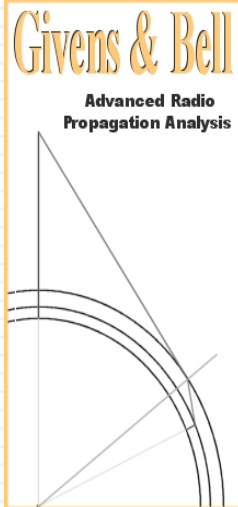

# Free Space Loss (Dispersion)

- In P.1546, Free Space Loss (FSD), is determined using the usual formula and applies to all distances.
- The free space loss computations in ITU-P.1546 do not include the vertical difference between the transmit and receive heights in the path distance.
- The approximations can consider either. When including the vertical distance extension, the paper and worksheets refer to the use of Free Space Dispersion (FSD).

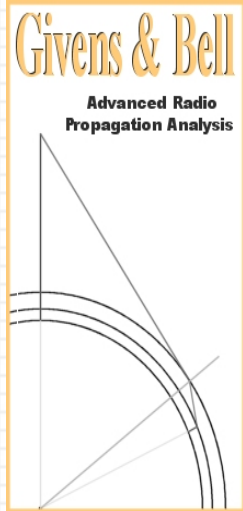

# Radiative Transfer Functions

- Radiative Transfer Functions, are long, complex calculations that separately consider the direct attenuation loss, cohesive scatter functions, incohesive scatter functions, and ground reflections, over, around, and under ground clutter.
- I primarily considered the QuinetiQ report, “A Generic Model of 1-60 GHz Radio Propagation through vegetation – Final Report” and several ITU Recommendations (see References) in determining the RTE equations for this project.

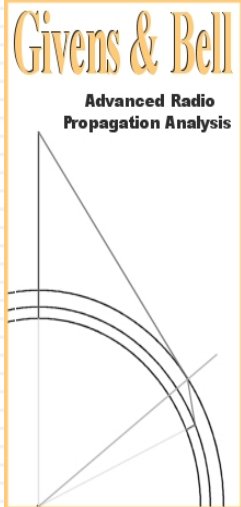

# The base equation

- The base equation that works to compute P-1546 clutter loss in the line-of-sight range, is a radio frequency version of Beer's Law.
- $A = AB * C * D$ , stated in the paper as:
- $A_{CL} = AB * clp * C$
- $A_{CL}$  is Attenuation due to clutter
- $AB$ , depending on the propagation situation, is a RTE function approximation.
- $clp$  is the clutter path absorption distance.
- $C$  is the clutter density (for ITU, set at 1.0)

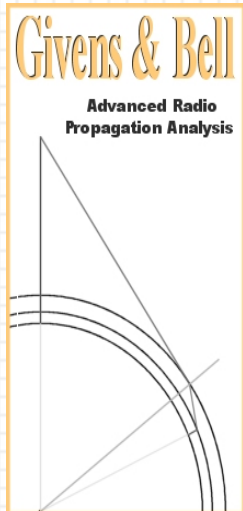

## Where the transmitter and receiver are both in, or at the height of, the clutter:

- For the first few meters, AB is a constant: 0 .0195 dB/meter. This is the beginning of the RTE Iri mode.
- I found that the Iri mode has both vertical and horizontal terms.
- By using iteration to solve the vertical term, I found that the clutter canopy height in P.1546-2 is a consistent 25.3 meters, from 1 km past 80 km.
- At 50 meters into the clutter, the RTE RTE I1 mode loss becomes less than the Iri loss, and takes over as the path of least attenuation.
- The I1 mode is in control for only a few meters.
- The I2 mode then provides the lowest attenuation path to the receiver.

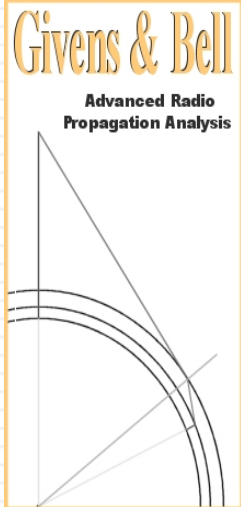

# The Below-Clutter-Canopy Equations:

- Iri vertical term:  $C_{AB} = (C_H - h_1)(2.06943 - 1.56184 \exp(C_H - h_1))^{-1}$  in dB/m, where :
  - $C_H$  is the clutter canopy height.
  - (for P.1546-2,  $C_H$  is 25.3 meters.)
  - $h_1$  is the transmitter height above ground level in meters.



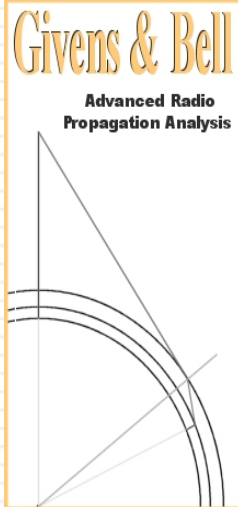

# The Below-Clutter-Canopy Equations:

- Iri horizontal term:  $C_{AB2} = (17.98 - .84224(C_H - h_1))e^{-0.00061(d1)}$  in dB/m, where :
  - $C_H$  is the clutter canopy height.
  - (for P.1546-2,  $C_H = 25.3$  m.)
  - $h_1$  is the transmitter height above ground level.
  - $d1$  is the cluttered path distance.

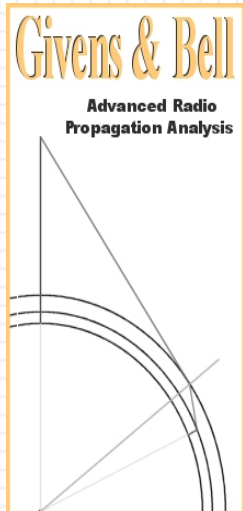

# The RTE Id mode submodes

- The RTE Id mode has two submodes, are I1 and I2.
- I found that I1, which provides only a slightly less path attenuation than I2, and only for a short distance, can often be ignored, skipping to I2.
- Below the clutter canopy, the RTE I2 mode provides the lowest loss path to the horizon.

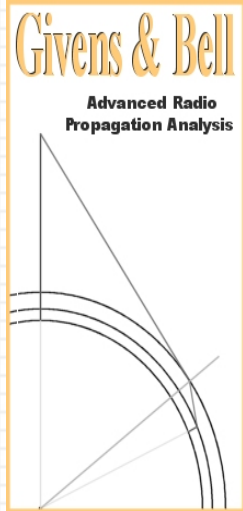

## RTE Id attenuation at or below the clutter canopy.

- The Id attenuation term for below the clutter canopy is:  
$$RT = 1.348 * 20 * \log(d1 + 1) \text{ dB.}$$

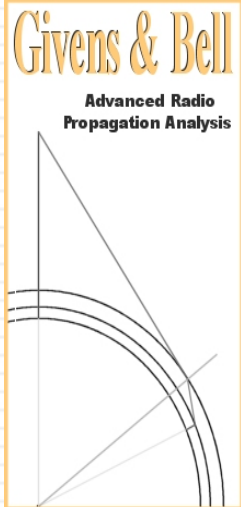

# Combined attenuation below the clutter canopy

- The combined attenuation at or below the clutter canopy at 100 MHz, is calculated by summing:
- Free Space Loss (or Dispersion)
- The RTE Iri vertical term
- The RTE Iri horizontal term
- RTE Id term
- $A = FSL + C_{AB} + C_{AB2} + RT$
- This, and a frequency compensation term, provides the computation for the at-or-below clutter canopy scenario (rows 43 - 47 of the worksheet).

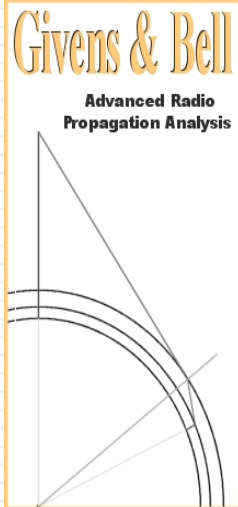

# Above the Clutter Canopy

- The radio path changes from a straight line through the clutter, to a refraction path determined by Snell's law.
- The Iri vertical path term,  $C_{AB}$ , which went to zero at the clutter canopy, disappears.
- The Iri horizontal path term,  $C_{AB2}$ , changes.
- The “above-canopy” scenario  $I_d$  term provides the least path attenuation only up to 225 meters through the below-canopy clutter, giving way to a new term,  $I_3$ .
- $I_3$  is a combination term, a 50-50 weighted combination of a third RTE function, and direct Beer's law absorption loss.

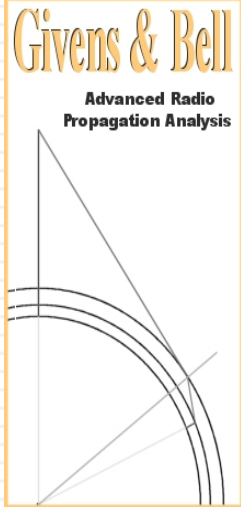

# Non-free space attenuation at $h_1 = 1200$ m., $f = 100$ MHz

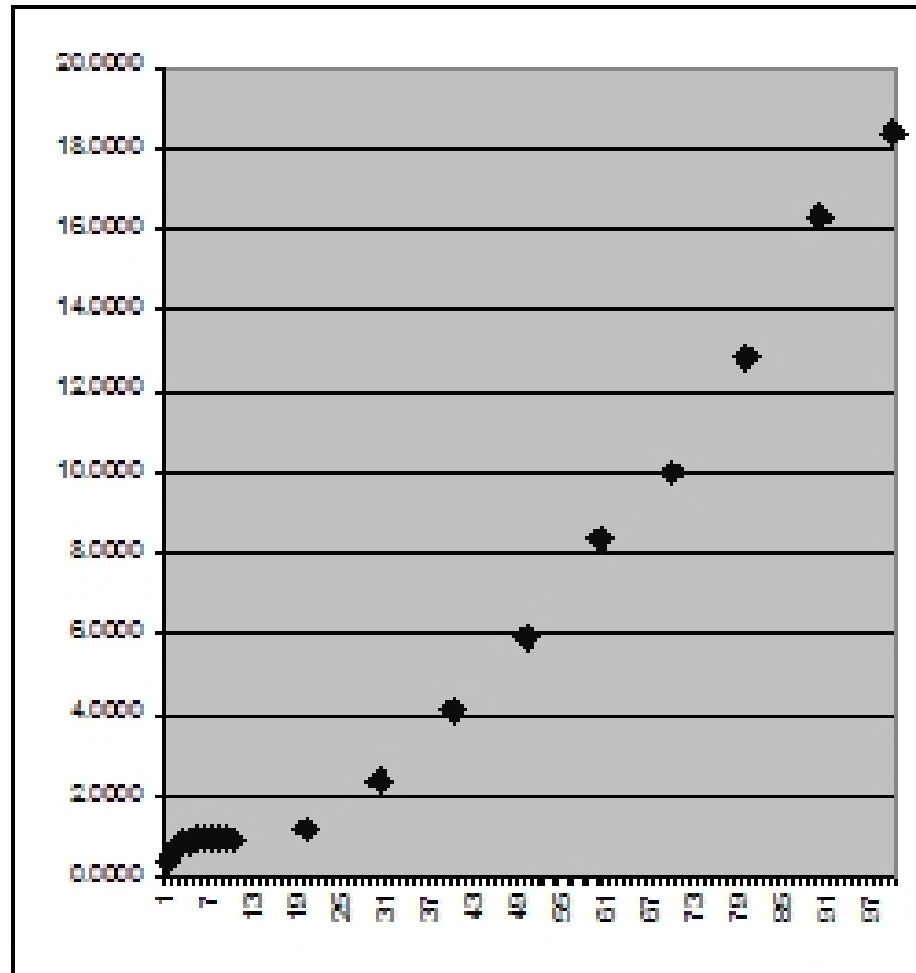

Givens & Bell

Advanced Radio  
Propagation Analysis

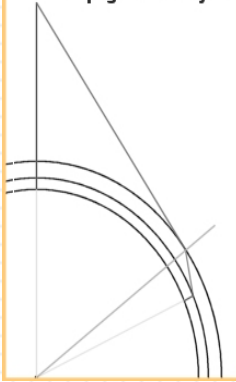

# Snell's Law in action (optical)

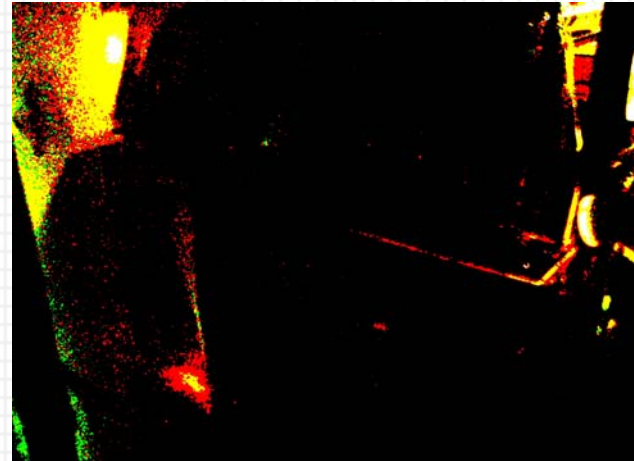

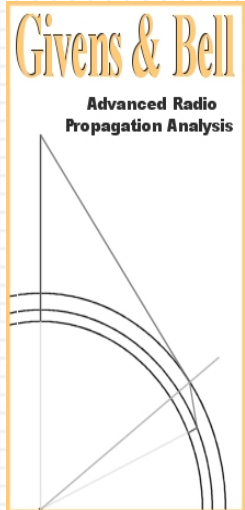

# Snell's Law Geometry

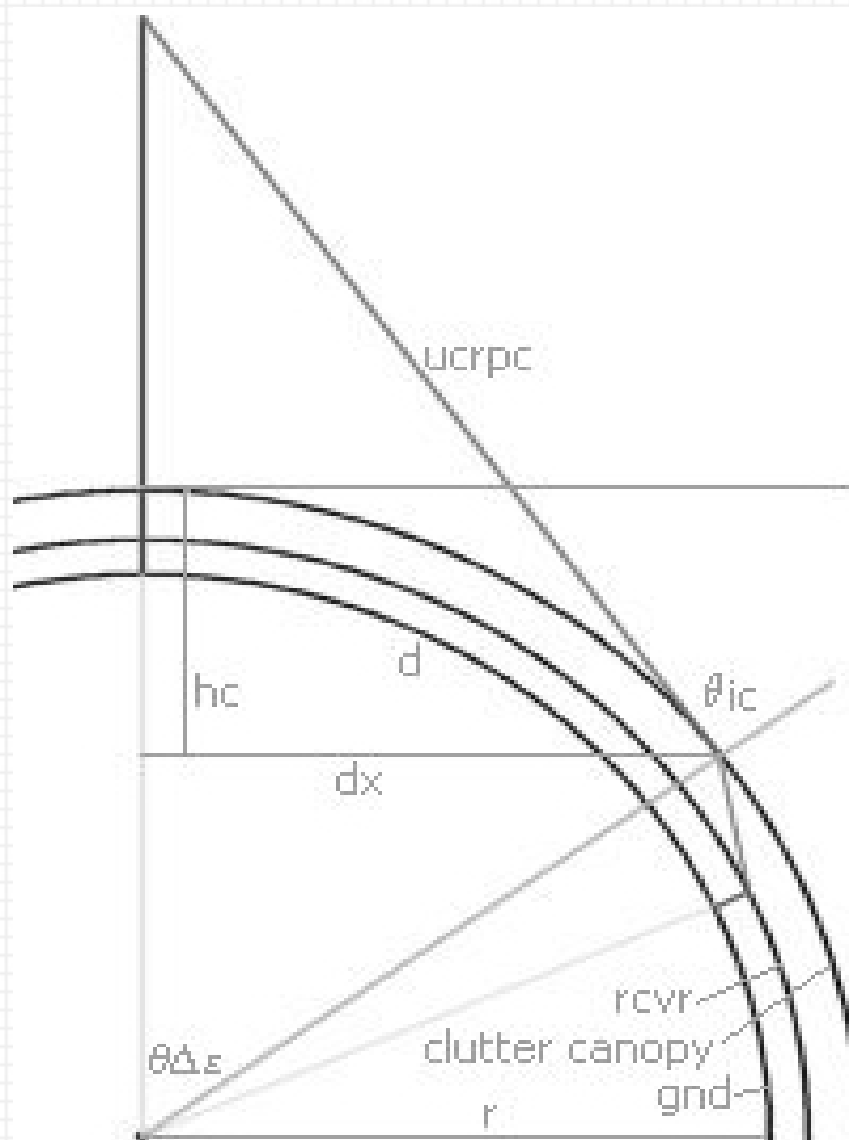



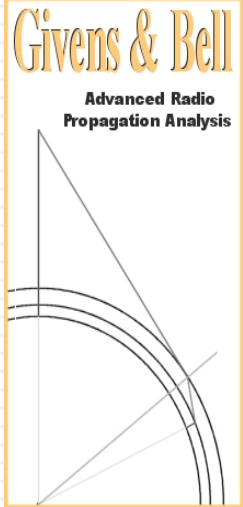

# Snell's Law Geometry Fig. 2

Figure 2.  
Snell's Law Geometry

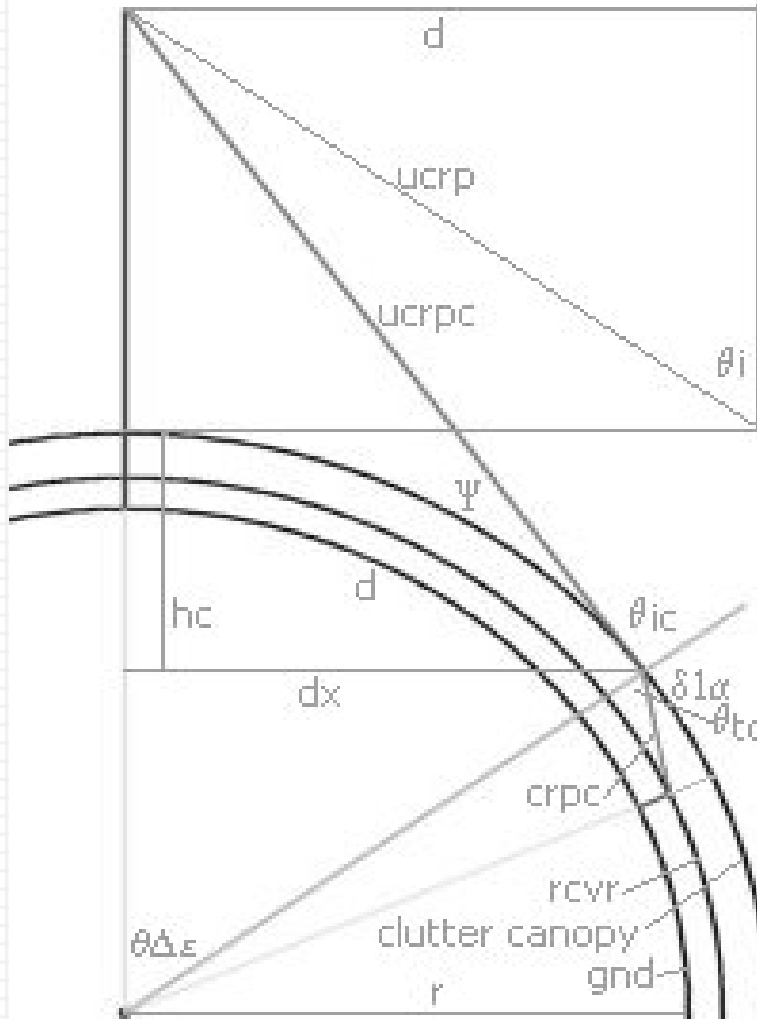

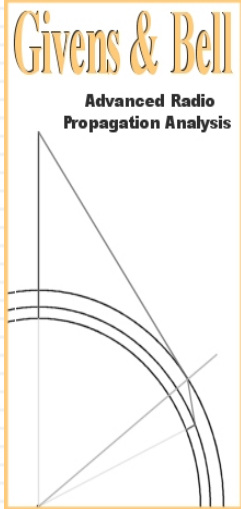

## RTE Iri above the clutter line

- The term for the RTE Iri mode above the clutter line for  $f=100$  MHz is:
- $Iri = .0195 * crpc - 20 \log(T)$  dB
- $crpc$  is the cluttered radio path distance under the canopy; includes both vertical and horizontal distance, see Fig. 2

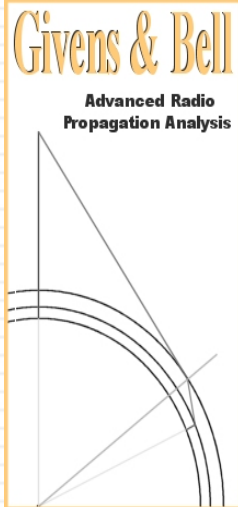

# RTE Id (I1 and I2) above the clutter line for $f = 100$ MHz

- At or above  $h_1 = 1000$  meters, the Id attenuation is:
- $I_{1,2}_{[h_1 > 1\text{km}]} = d_{1a}[0.03\exp(-.14d)]$
- At a  $h_1 >$  clutter canopy height and  $< 1000$  meters, the Id attenuation is:
- $I_{1,2}_{[h_1 < 1\text{km}]} = d_{1a}[0.07\exp(-.17d)]$
- Note: typo in paper on second equation;  $[CH < h_1 < 1\text{km}]$ , not  $[h_1 > 1\text{km}]$
- $d_{1a}$  is the horizontal distance along the top of the clutter canopy from the entry point of the rf to the receiver. Units in meters. See Fig. 2

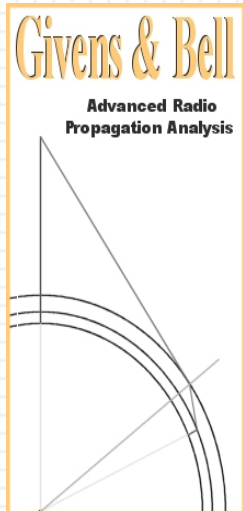

## The RTE I3 function at f=100 MHz

- The equation for the RTE I3 function at f=100 MHz is:  $I3 = d1a[.00055d + \log(d)(.041 - 0.0017(h1)^{1/2} + 0.019)] - 0.9(20\log(R)/\exp(h1/37.5))$
- d is the total path distance, tx to rcvr.
- Note: d1a in meters, d in km.

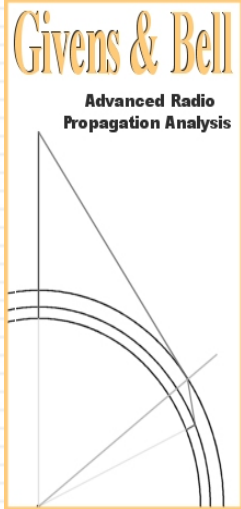

# Beyond the Horizon

- In the diffraction range, beyond the horizon, P-1546 does not provide the terrain information necessary to provide a deterministic based solution. An empirical formula is used to compute the non-FSL losses beyond the horizon determined by the Snell's law geometry:
- $ADIFF_{[100\text{MHz}]} = 0.0665d + 48.35 - 0.356(h1 - h2)^{1/2}$

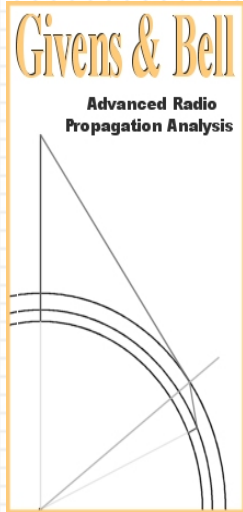

# Frequency Compensation

- The equations were primarily developed using ITU-R P.1546 Figure 1 – 100 MHz.
- Compensation equations for other frequencies were based on Figures 9, and 17, as stated in the paper, and implemented on the worksheet.

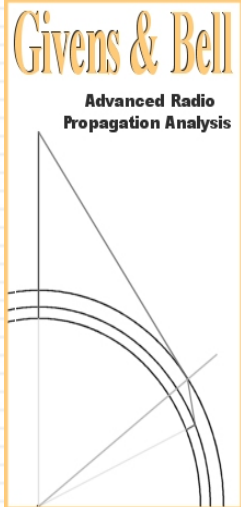

# Project Status

- The ITWOM software, using these RTE approximations to supplement the original ITM methodology, is currently in the final stages of debugging and calibration prior to beta release of test systems to early access sponsors.
- First commercial product, the original market-by-market FM vehicular reception analysis, is to be available for order through BIAfn's Dataworld division at the fall NAB Radio Show.



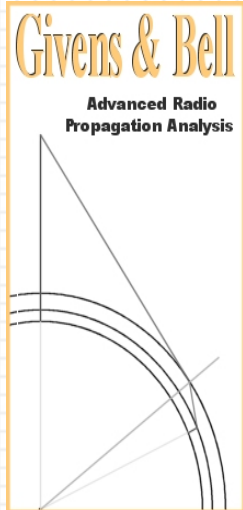

# Thank You

**Givens & Bell, Inc.**

**1897 Ridge Rd.**

**Haymarket, VA 20169**

**703.753.8951**

**also check: [LongleyRice.com](http://LongleyRice.com)  
for news on the ITWOM [after July  
4, 2008]**



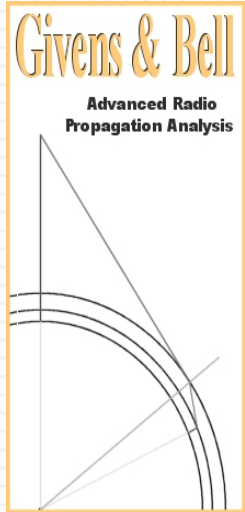

# ITM

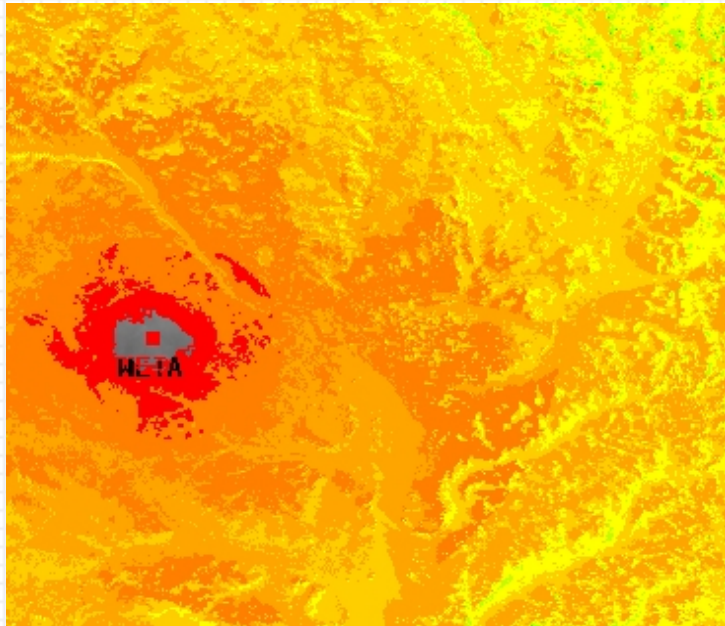

# ITWOM

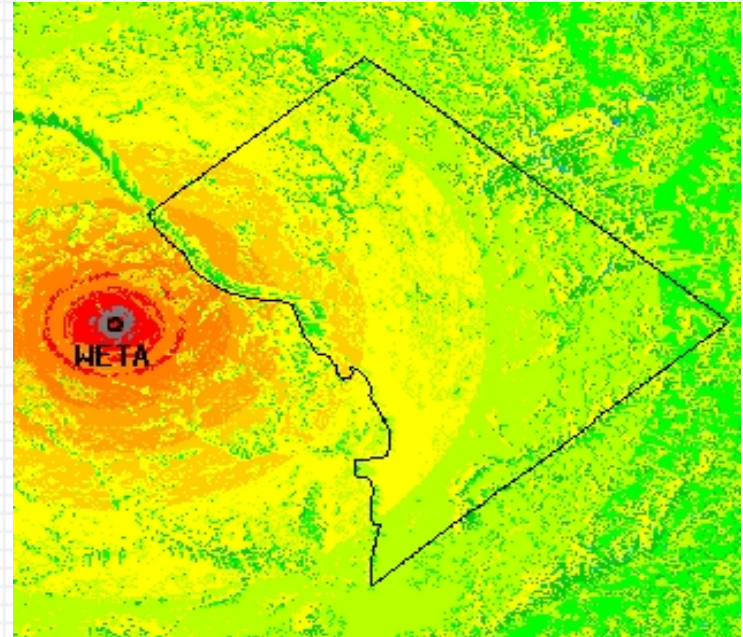

Givens & Bell

Advanced Radio  
Propagation Analysis

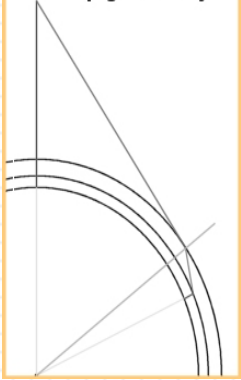

# ITM

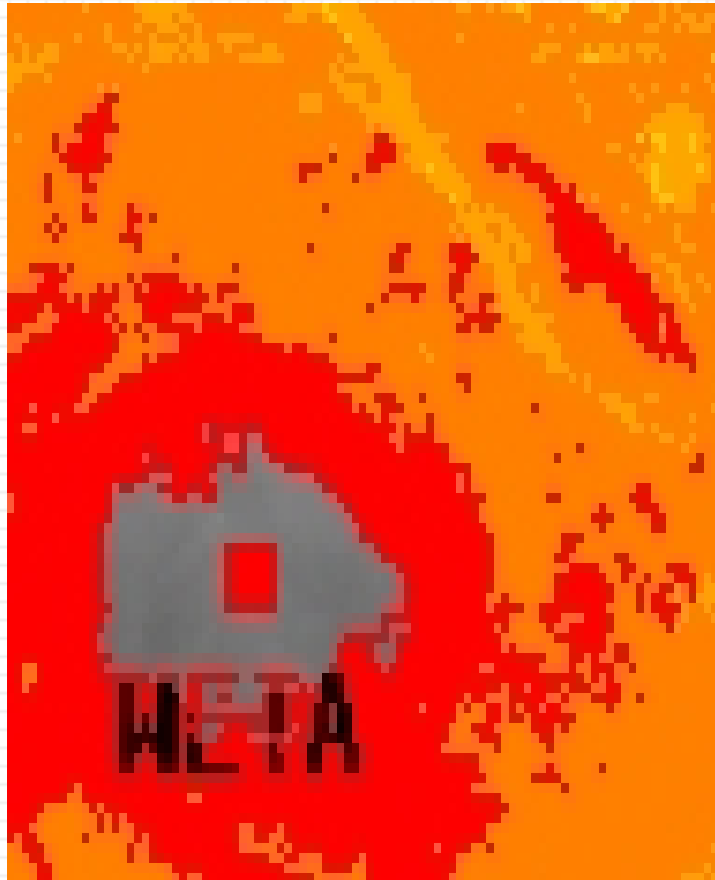

# ITWOM

